

# THE LABORATORY

# FLUID BED DRYER

## OPERATOR MANUAL

SHERWOOD SCIENTIFIC LIMITED  
1 THE PADDOCKS  
CHERRY HINTON ROAD  
CAMBRIDGE  
CB1 8DH  
ENGLAND  
Tel. +44 (0) 1223 243444  
Fax. +44 (0) 1223 243300  
[info@sherwood-scientific.com](mailto:info@sherwood-scientific.com)  
[www.sherwood-scientific.com](http://www.sherwood-scientific.com)

© Copyright Sherwood Scientific Ltd, 2006

# Contents

|  |       |    |
|--|-------|----|
| Safe Use Of The Instrument                       | ..... | 3  |
| Setting Up The Instrument                        | ..... | 3  |
| 1. Introduction                                  | ..... | 4  |
| 1.1 Instrument Description                       | ..... | 4  |
| 1.2 The Basic Principles of Fluidised Beds       | ..... | 5  |
| 1.3 The Drying Process                           | ..... | 5  |
| 2. The Laboratory Fluid Bed Dryer                | ..... | 6  |
| 2.1 Drying Tubs & Accessories                    | ..... | 6  |
| 2.2 The Dryer System                             | ..... | 9  |
| 2.3 Range of Materials                           | ..... | 11 |
| 2.4 Optimum Bed Depth                            | ..... | 11 |
| 3. Typical Applications                          | ..... | 12 |
| 4. Operating Procedure                           | ..... | 14 |
| 4.1 Drying and Determination of Moisture Content | ..... | 14 |
| 4.2 Determination of Drying Curves               | ..... | 15 |
| 4.3 Calculation of Heat Transfer Coefficients    | ..... | 16 |
| 4.3.1 Constant Rate                              | ..... | 16 |
| 4.3.2 Falling Rate                               | ..... | 16 |
| 4.4 Analogue Dryer Controls                      | ..... | 17 |
| Timed Cycle Mode                                 | ..... | 17 |
| Temperature Controller                           | ..... | 18 |
| 4.5 Digital Dryer Controls                       | ..... | 19 |
| Timed Cycle Mode                                 | ..... | 19 |
| Temperature Controller                           | ..... | 21 |
| 5. General Maintenance                           | ..... | 23 |
| 5.1 Disassembly                                  | ..... | 23 |
| 5.2 Replacement                                  | ..... | 23 |
| 5.2.1 Heater Element                             | ..... | 23 |
| 5.2.2 Temperature Controller                     | ..... | 23 |
| 5.2.3 Blower Speed Controller                    | ..... | 24 |
| 5.3 Removal of Air filter for Cleaning           | ..... | 24 |
| Warranty Statement                               | ..... | 25 |

## SAFE USE OF THE INSTRUMENT

Sherwood Scientific Ltd makes every possible effort to ensure that the instruments it supplies are designed and constructed to be safe and without risk to health or property when used properly. In accordance with relevant EU Directives, they are marked with the CE symbol to indicate they comply with all relevant European safety and hygiene requirements. However, please note, that instruments can cause injury if you are careless and do not follow the operating instructions.

Ensure that you and all others working nearby know the location of the instrument controls and how to use them; especially the front panel Operations On/Off button and the Power On/Off switch located on the back of the instrument.

Ensure that you have read the relevant parts of this manual before attempting to use or work with the instrument. For your own safety and those of others, please ensure the operator or personnel in charge of the location has received proper training.

## SETTING UP THE INSTRUMENT

The instrument will arrive packed in a purpose designed box having a packing slip. Ensure that all the system components arrive safely. To form an operating system there are three components which are required. The instrument, the tub assembly, and a suitable filter for the tub assembly.

The location of the dryer should be chosen for the intended use. For use with samples where dust may be generated or for frequent use on samples with high moisture content, we suggest positioning the dryer in a fume hood. The side panels of the instrument and the underside have air vents provided for supplying cooling air for the inside of the cabinet. Ensure there is enough space adjacent to these vents to allow air to enter the instrument.

## 1

## INTRODUCTION

## 1.1 INSTRUMENT DESCRIPTION

The dryer is of simple, compact design, conveniently portable and easy to operate, the only requirement being a mains power supply. The source of power should be within the reach of the instrument lead so that no extension wires are required.

The instrument contains the air distribution system, heater element, thermostat, and electrical controls. There are many types of tub assemblies to choose from which can be used with the FBD. (See our website [www.sherwood-scientific.com](http://www.sherwood-scientific.com)). The main components are shown below: -

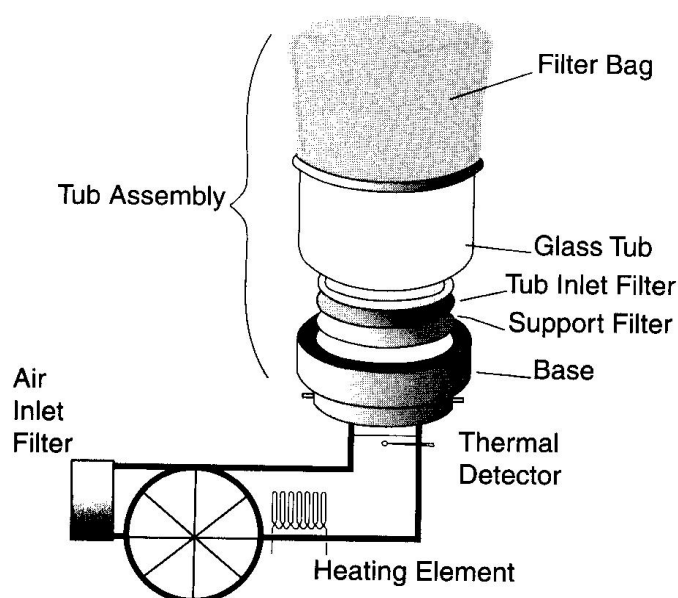

Air is drawn in through a Stainless Steel Inlet filter in the back of the instrument and blown by the centrifugal fan over a 2kW electrical heater and through a stainless steel filter gauze at the top of the dryer body. A 5 litre sealed glass tub is shown having a tub base which attaches to the instrument by means of a bayonet fitting. There is an "O" ring seal between the tub assembly and the instrument. At the inlet of the tub assembly, there is a 60 mesh stainless steel support filter and a fine-mesh nylon filter. These filters retain the sample in the tub assembly while assuring a uniform distribution of air enters the assembly. A filter bag is clipped on to the top of the tub by means of an elasticated waist, which also keeps the sample particles from escaping the tub assembly. The wide range of tub assemblies which are available are designed to match the variety of sample types and drying applications.

The above dryer can be used as a stand alone unit, with full control of the flow rate, inlet temperature, and time of drying. The values of the inlet set temperature, actual inlet temperature and time remaining in the drying cycle can be obtained by directly reading from the front panel.

## 1.2 THE BASIC PRINCIPLES OF FLUIDISED BEDS

When a stream of gas is passed upwards through a bed of material at a certain velocity the bed will first expand, then become suspended and agitated by the gas stream to form a fluidised bed. This has the appearance of boiling liquid due to the formation of many small bubbles - the so-called "bubbling fluidisation".

At higher gas velocities, larger bubbles and plugs of material are formed resulting in a more violent type of fluidisation called slugging or spouting. Although smooth bubbling is preferred, some materials - especially those of uniform size - may be more amenable to spouting fluidisation. The optimum operating gas velocity for bubbling fluidisation lies above the minimum fluidising velocity but below the velocity of entrainment of the material.

## 1.3 THE DRYING PROCESS

If a bed of wet material is fluidised by a heated air stream, as in the laboratory batch dryer, the conditions are ideal for drying. The very efficient contact between gas and solid particles due to the turbulence of the bed results in high heat transfer rates causing rapid evaporation (mass transfer) of moisture which is carried away with the exit air. This process has a high thermal efficiency because most of the heat input is used in vaporising the moisture and the exit air only rises in temperature as drying nears completion.

Because of the very good mixing of particles in the fluidised state, the conditions of temperature and moisture content are uniform throughout the bed therefore a uniform product is obtained. Also the product is not affected because fluidisation causes very little abrasion and the temperature can be adjusted to ensure no loss of properties for heat-sensitive materials.

The same principles apply for industrial fluid bed dryers - both batch and continuous types, therefore the laboratory fluid bed dryer can be used to assess the feasibility of different materials for large scale fluidised drying.

# 2

## THE LABORATORY FLUID BED DRYER

The dryer is of simple, compact design, conveniently portable and easy to operate, the only requirement being a mains power supply. The cabinet contains the air distribution system and electrical controls. Air is drawn in through a mesh filter and blown by the centrifugal fan over a 2kW electrical heater and through a stainless steel filter gauze at the top of the dryer body.

The tub unit consists of a container with a fine-mesh, nylon gauze air distributor and stainless steel support gauze. This channels the air uniformly and supports the bed. A filter bag, which fits over the top of the tub, retains any particles expelled from the fluidised bed. Filter bags are available in nylon, terylene and polypropylene to suit a range of process conditions.

### 2.1 DRYING TUBS & ACCESSORIES

The tub unit locks into position within the cabinet by a simple bayonet fitting and the base of the tub is removable to allow replacement of the distributor gauze. The filter bag for the exit gases has a retaining ring that slips over the top of the tub.

Tubs are available in two sizes: 2 litres and 5 litres and two materials - stainless steel and glass.

The main advantage of the stainless steel tubs is durability. High-grade stainless steel is used since the process requirements usually call for high product purity and good chemical and corrosion resistance at high temperature. The glass tubs have an advantage in the operator being able to see the sample as it dries. The optimum flow rate is easy to select judging by the appearance of the fluidised sample. The operator is often able to estimate the state of dryness and guess the shape and size distribution of the particles simply by the appearance of the sample flowing in the tub.

The multi-tub head - using four small capacity tubs - is a useful addition to the dryer. It enables small quantities of material to be dried simultaneously and rapidly, either as a preliminary to further processing, as may be required in research laboratories, or for moisture determinations in analytical and process control laboratories.

The mini tubs are 250ml in capacity and can be used effectively on samples weighing from 5 to 50 grams per tub. Four tubs can be dried simultaneously.

**Chapter 2 The Laboratory Fluid Bed Dryer****2.1 Drying Tubs & Accessories**

continued

The 3 micron polyester filters can be used for the mini tubs as well as the 2 and 5 litre tubs. These filters are effective for 5 to 25 micron particles. Please note that these filters greatly reduce the flow rate of air through the sample. Drying times normally occurring between 10 to 30 minutes can take up to several hours using these small pore size filters. Furthermore, the use of these filters may even hinder the mixing of sample particles during drying. Many of the main advantages of fluid bed drying may be lost. If in doubt, Sherwood offers to do an initial study on your sample which will ensure proper accessories are chosen for the application.

A wet sample should occupy about 1/3 of the tub assembly volume. As it dries and the density drops, the apparent volume will increase to about ½ the volume. Tubs should be purchased that are 3 x the volume of the sample size.

## Chapter 2 The Laboratory Fluid Bed Dryer

### 2.1 Drying Tubs & Accessories

continued

| Part Number  | Description of Item                         |
|--|---|
| <b>LARGE TUB ASSEMBLIES &amp; FILTER BAGS</b>                      |   |
| 50035005   | 2 LITRE STAINLESS STEEL TUB & BASE          |
| 50035006   | 2 LITRE GLASS TUB & BASE                    |
| 50035008   | 5 LITRE STAINLESS STEEL TUB & BASE          |
| 50035009   | 5 LITRE GLASS TUB & BASE                    |
| 50035400   | NYLON FILTER BAG - LARGE                    |
| 50035402   | TERYLENE FILTER BAG - LARGE                 |
| 50035404   | POLYPROPYLENE FILTER BAG - LARGE            |
| 50035407   | NOMEX FILTER BAG - LARGE                    |
| <b>SEALED TUB &amp; TOP CAP FILTERS</b>                            |   |
| 50035014   | 5 LTR SEALED GLASS TUB & BASE               |
| 50035020   | TOP CAP with 50 MESH ST.ST. FILTER          |
| 50035021   | TOP CAP with 250 MESH ST.ST. FILTER         |
| 50035022   | TOP CAP with 500 MESH ST.ST. FILTER         |
| 50035023   | TOP CAP with NYLON FILTER BAG               |
| 50035024   | TOP CAP with 3 MICRON POLYESTER FILTER      |
| <b>MINI TUB ASSEMBLIES &amp; FILTER BAGS</b>                       |   |
| USE FOUR MINI TUBS WITH A MULTI TUB BASE                           |   |
| 50035011   | MULTI-TUB BASE                              |
| 50035012   | MINI ST.ST. TUB                             |
| 50035013   | MINI GLASS TUB                              |
| 50035401   | NYLON FILTER BAG - SMALL                    |
| 50035403   | TERYLENE FILTER BAG – SMALL                 |
| 50035405   | POLYPROPYLENE FILTER BAG – SMALL            |
| 50035408   | NOMEX FILTER BAG – SMALL                    |
| <b>SEALED TUBS &amp; FILTERS</b>                                   |   |
| 500 350 33   | MINI SEALED GLASS TUB                       |
| <i>REQUIRE CAP, ST.ST. SUPPORT, TOP FILTER &amp; BOTTOM FILTER</i> |   |
| 50002010   | SCREW CAP for MINI SEALED TUB               |
| 50035301   | NYLON MINI TOP FILTER                       |
| 50035302   | 3 MICRON POLYESTER MINI TOP FILTER          |
| 50035303   | 250 MESH ST.ST. MINI TOP FILTER             |
| 50035304   | 500 MESH ST.ST. MINI TOP FILTER             |
| 50035305   | NYLON MINI BOTTOM FILTER                    |
| 50035306   | 3 MICRON POLYESTER MINI BOTTOM FILTER       |
| 50035307   | 250 MESH ST.ST. MINI BOTTOM FILTER          |
| 50035308   | 500 MESH ST.ST. MINI BOTTOM FILTER          |
| 50035309   | 60 MESH ST.ST. MINI BOTTOM FILTER (SUPPORT) |



## 2.2 THE DRYER SYSTEM

The dryer cabinet incorporates an electrical heater, temperature controller, timer and air blower fan.

The air blower is controlled by a thyristor circuit to give a smooth variation over a wide range of motor speeds. This enables efficient fluidisation to be achieved for different materials, and gives fine control of the drying temperature.

Some materials, particularly uniformly sized materials like peas or lentils, may be difficult to fluidise smoothly. However, the more violent slugging or spouting type of fluidisation may be obtained which also has good heat transfer characteristics, and has applications in drying of granular materials and foodstuffs, coating of tablets, and granulation of fertilisers.

The heater is a 2kW coiled element which gives air inlet temperatures to the fluidised bed of up to 200<sup>o</sup>C. A three-term temperature controller gives an accuracy of  $\pm 1^{\circ}\text{C}$  over the complete operating range.

Air velocity is variable using the blower speed control, which is graduated from 1 to 10 for ease of operation. Table 1, below, shows the relationship between blower speed setting and air velocity.

| <b>BLOWER SETTING</b> | <b>AIR VELOCITY</b> |                 | <b>VOLUME FLOW-RATE</b> |                     |
|-----------------------|---------------------|-----------------|-------------------------|---------------------|
|                       | <b>metres/sec.</b>  | <b>ft./min.</b> | <b>litres/sec.</b>      | <b>cu. ft./min.</b> |
| 1/2                   | 1.80                | 360             | 14.9                    | 31.4                |
| 3                     | 1.85                | 370             | 15.3                    | 32.2                |
| 4                     | 2.03                | 405             | 16.7                    | 35.4                |
| 5                     | 2.25                | 450             | 18.6                    | 39.3                |
| 6                     | 2.45                | 490             | 20.2                    | 42.8                |
| 7                     | 2.75                | 550             | 22.7                    | 48.0                |
| 8                     | 3.10                | 620             | 25.6                    | 54.1                |
| 9                     | 3.50                | 700             | 28.9                    | 61.1                |
| 10                    | 3.65                | 730             | 30.1                    | 63.7                |

Table 1.

The unit can be used in either manual or automatic mode. The sequence timer allows the user to pre-set any cycle time between 0.1 seconds and 9990 hours duration. An audible alarm will sound at the end of each drying cycle and the unit will automatically switch off to allow weighing of the sample. After each timed cycle the unit must be reset using the stop/reset control button.

**Warning!**

When Operating a Dryer above 65°C we recommend making a copy of the following warning sign so that it can be displayed next to the instrument and tub assembly.



Stick on thermal labels can be also provided for all 2 and 5 litre tub assemblies on request and should be positioned in the most visible location if the instrument will be used at elevated temperatures.

The use of microprocessors in the instrument allows us to control the temperature during heating and cooling the sample to within a few degrees.

**Note: -**

Good temperature control is only obtained when a tub assembly is in position on the instrument. Without a tub assembly, the air flows without resistance and a wide deviation may be observed between the set temperature and that actually achieved.

## 2.3 RANGE OF MATERIALS

The wide range of materials that can be dried includes fine powders, coarse particles, crystals, granules, slurries or pastes (after decanting, or pre-drying or by spraying into bed of initially dried material). Materials with moisture content up to 80% such as some polymers, dyestuffs and molecular sieve catalysts can also be accommodated. In addition, heat sensitive materials including foodstuffs such as peas, wheat and lentils, may be dried at relatively low temperatures.

### **Warning:-**

**The FBD is not an explosion proof instrument and therefore samples having volatile compounds that are flammable or able to reach their flash point should not be used with this dryer.**

Because of the high heat and mass transfer rates obtainable, drying times for the Laboratory Fluid Bed Dryer are much less than for the more traditional methods available in laboratories such as oven or vacuum drying. Many materials can be dried in less than 15 minutes including those with high "bound" moisture content e.g. resins. Typical drying curves for materials eminently suitable for fluidised drying are shown in Fig 1 of the product data sheet.

The more volatile solvents such as methanol are vaporised which is potentially explosive, so these should not be used in the fluid bed dryer.

## 2.4 OPTIMUM BED DEPTH

The optimum bed depth is that which can be fluidised at the required temperature by relatively high air velocity, bearing in mind that as drying proceeds the bed becomes easier to fluidise i.e. the air velocity can be progressively reduced. This optimum bed depth will vary appreciably with the material - an initial bed depth of about 75mm. is typical and a trial and error procedure is generally used to identify the optimum. Particle sizes in the range 0.1mm to 5mm are most suitable and the size ratio largest:smallest should not be more than 8.

# 3

## TYPICAL APPLICATIONS

1. Simple drying of a material to give moisture content and the drying time (or residence time) required.

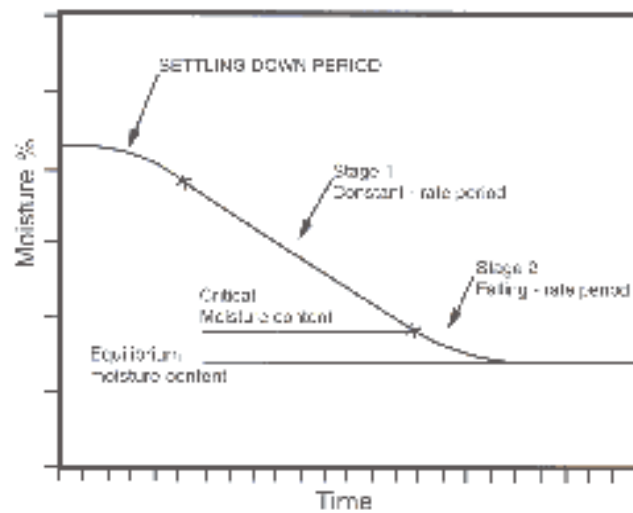

Figure 2 Moisture Content vs. Time

2. Fluidising curves give the variation of pressure drop with air flow-rate showing the feasibility of fluidisation and the conditions for minimum and operating fluidisation velocity.
3. Determination of drying curves - to assess feasibility of fluidised bed drying of a material on an industrial scale. Drying curves are relevant to the mechanism of drying. They may be used as a basis for heat and mass balances, thermal efficiency of drying and dryer design.

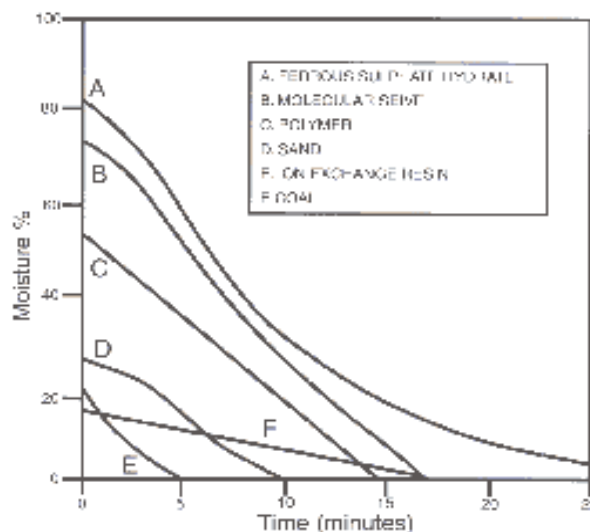
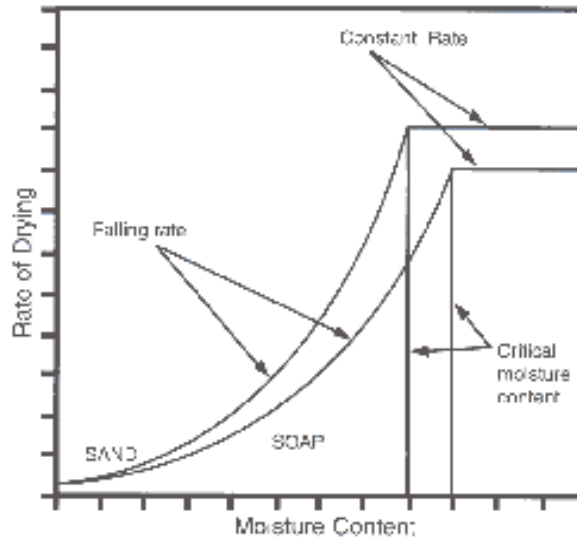

Figure 3 Typical Drying Curves

4. Calculation of heat transfer coefficients for different conditions - relevant to dryer design and comparison of fluidised beds with other drying methods.



**Figure 1** Rate of Drying vs. Moisture Content

# 4

## OPERATING PROCEDURE

### 4.1 DRYING OF MATERIAL & DETERMINATION OF MOISTURE CONTENT

Remove any excess water from the sample by decanting and/or using a filter pump. Place the sample in the dryer at a pre-determined bed depth compatible with the operating range of the dryer as previously indicated. In some cases the moisture content may be too high for immediate fluidisation to be effected, but after some initial drying fluidisation becomes possible.

Weigh container empty, then with the material.

Fit a clean bag over the container, locating the sealing ring into its groove on the tub.

Switch on the mains supply.

Select the drying temperature.

Select manual or automatic mode of operation. Push cycle start button.

Select blower and heater settings. Adjust blower speed to achieve good fluidisation - as determined by observation. The blower speed will correspond to the fluidisation velocity required which will normally be above the minimum fluidisation velocity  $U_{mf}$  and in the range of  $1\sim 2U_{mf}$ .

In normal mode, when drying nears completion as judged by a rise in temperature of outlet air or visual observation, push stop button to stop cycle. Remove the tub with contents and re-weigh, continue repeating the drying cycle until a constant weight is obtained. This occurs when the sample has reached its equilibrium moisture content. For each weighing the dryer is stopped and then restarted. The difference in initial and final weights of the material can be expressed as the moisture content on wet or dry basis.

In the automatic mode, once the pre-set time has elapsed the cycle will automatically stop and the alarm will sound. This can be reset by means of the red stop button.

The total drying time for the material can be calculated by multiplying the interval cycle time by the number of cycles required. The dry material is removed from the dryer and may be stored for further analysis or processing.

## 4.2 DETERMINATION OF DRYING CURVES

Drying curves are obtained by a similar procedure to that used for a simple drying operation. They establish the drying characteristics of the material including drying rates, constant rate and falling rate periods, drying times, equilibrium moisture content and critical moisture content and heat transfer coefficients.

### **PROCEDURE:**

Weigh the empty tub, then as for simple drying, place the sample of material in the tub to an appropriate bed depth as determined by trial. Weigh the tub with the material. Fit a filter bag over the tub locating the sealing ring into the groove.

Switch on the mains supply and select the drying temperature required as described in section 4.1.

Using a suitable form of hygrometer note the wet and dry bulb temperatures (and thus humidity) of the inlet air to the fan and the outlet air from the fluidised bed.

Weigh the tub with material at 2 minute intervals for about 15 minutes (or as long as it takes to attain constant weight) recording the wet and dry bulb temperature before removing the tub for weighing. Then weigh at 5 minute intervals until constant weight is achieved indicating that the equilibrium moisture content has been reached. Record the drying time and moisture content.

From the results, plot drying curves of moisture content vs time and drying rate vs moisture content.

Some interpretations of the drying process are shown in Figs 2 and 3 in the product data sheet.

### 4.3 CALCULATION OF HEAT TRANSFER COEFFICIENT

#### 4.3.1 CONSTANT RATE PERIOD

heat lost by entering gas = heat transferred to solids to vaporise the liquid

Therefore  $\left(\frac{dw}{dt}\right)_c * L = -h_c * A * (T_A - T_S) \log mean \dots\dots\dots (1)$

Where:  $K = \frac{\left(\frac{dw}{dt}\right)_c}{(W_C - W_E)}$  constant drying rate (kg/s)

$h_c$  = heat transfer coefficient (W/M<sup>2</sup>/°C)

L = Latent Heat of vaporisation (J/kg)

A = surface area (m<sup>2</sup>)

T<sub>A</sub> = dry bulb air temperature (°C)

T<sub>S</sub> = wet bulb air temperature (°C)

Equation (1) can be integrated to give

$$h_c = \frac{(W_0 - W_C) * L}{t_c * A * (T_A - T_S) \log mean}$$

Where: W<sub>0</sub> = initial moisture content

W<sub>C</sub> = "critical" moisture content at end of constant rate period

t<sub>c</sub> = constant rate drying time

#### 4.3.2 FALLING RATE PERIOD

For resins and other materials where the moisture is bound strongly in the particle, diffusion of the moisture to the surface is slow and will therefore control the rate of drying. This may be represented by:

$$K = \frac{\left(\frac{dw}{dt}\right)_c}{(W_C - W_E)} \dots\dots\dots (2)$$

Where  $\left(\frac{dw}{dt}\right)_c * L = -h_c * A * (T_A - T_S) \log mean =$  falling period drying rate (kg/s)

at time t from start of falling rate.

W = moisture content at time t (kg)

W<sub>e</sub> = eq<sup>m</sup> moisture content at temperature and humidity of air (kg)

Re-organising (2) gives  $K = \frac{\left(\frac{dw}{dt}\right)_c}{(W_C - W_E)}$

Now, substituting for K &  $h_c = \frac{(W_C - W_E) * L * \ln(W_C - W_E)}{t_A * A * (T_A - T_S)_m (W - W_E)}$  in (2) and integrating gives

$$h_c = \frac{(W_C - W_E) * L * \ln(W_C - W_E)}{t_A * A * (T_A - T_S)_m (W - W_E)}$$

where: t = time from start of falling rate period.



## 4.4 ANALOGUE DRYER CONTROLS

### TIMED CYCLE MODE

The process timer is located on the left-hand side of the sloping control panel on the front of the instrument.

The timer fitted to the analogue FBD can be set to any time within five time ranges by turning the selector knob to point the red needle to your selection. The ranges are selected by turning the selector in the top right-hand corner every 60 degrees using a small screwdriver.

| Selector | Range            |
|----------|------------------|
| 6s       | 0.2s to 6s       |
| 60s      | 2s to 60s        |
| 6m       | 0.2min. to 6min. |
| 60m      | 2min. to 60min.  |
| 6h       | 0.2h to 6h       |

The timed cycle is started either when the manual/timed cycle switch is changed to the timed cycle position or, if timed cycle is already selected, when the start button is pressed. At the end of the cycle the timer resets, the audible alarm sounds and the dryer is automatically turned off. To cancel the alarm either switch back to manual operation or switch off the mains switch.

## ■ Precautions for Correct Use

### How to Change the Time Range

Change the time range by turning the knob clockwise using a flat-blade screwdriver or an Allen wrench. There are five possible settings. The selected time is displayed in the time range display window above the knob.

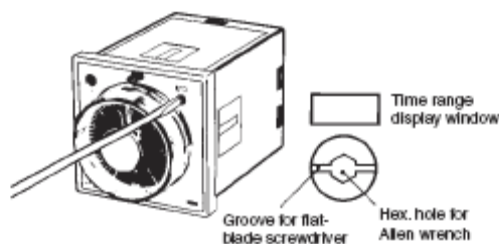

Do not change the time range while the timer is in operation.

## TEMPERATURE CONTROLLER

The temperature controller is located on the right hand side of the sloping control panel on the front of the instrument.

It can be set to any temperature in the range ambient to 200°C by turning the knob to point the red needle at your selection.

The temperature controller regulates the heater that raises the temperature of the air fed to the sample by the dryer. It will only operate if the heater switch is in the ON position.

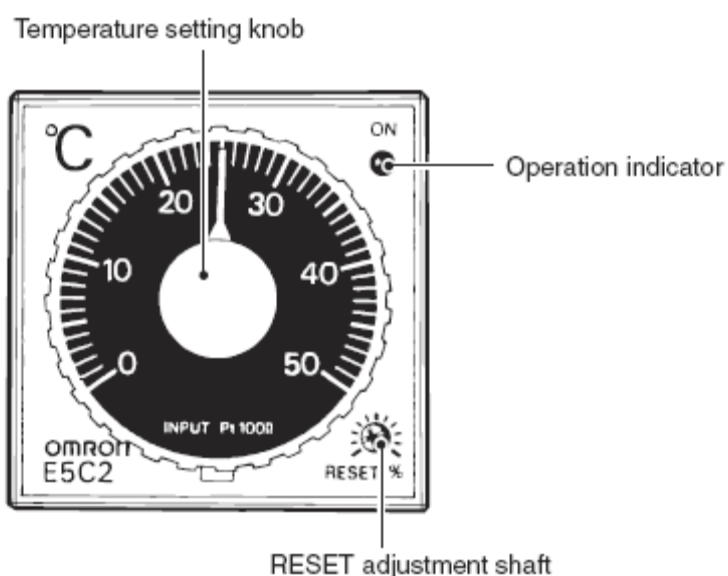

The operation indicator is lit when the heater is on and unlit when the heater is off. It will appear to flash when controlling at the set temperature.

## 4.5 DIGITAL DRYER CONTROLS

### TIMED CYCLE MODE

#### Upto s/n 14914

The process timer is located on the left-hand side of the sloping control panel on the front of the instrument.

The timer fitted to the digital FBD can be set to any time in the range to 99m 59s. It has push button rotary switch setting and a 4 digit LED display indicating elapsed time period. The time is set using buttons for each digit, + (for increment the set time) and - (decrement), and displayed in the windows of the rotary switches (see the diagram below).

The timed cycle is started either when the manual/timed cycle switch is changed to the timed cycle position or, if timed cycle is already selected, when the start button is pressed. At the end of the cycle the timer resets, the audible alarm sounds and the dryer is automatically turned off. To cancel the alarm either switch back to manual operation or switch off the mains switch.

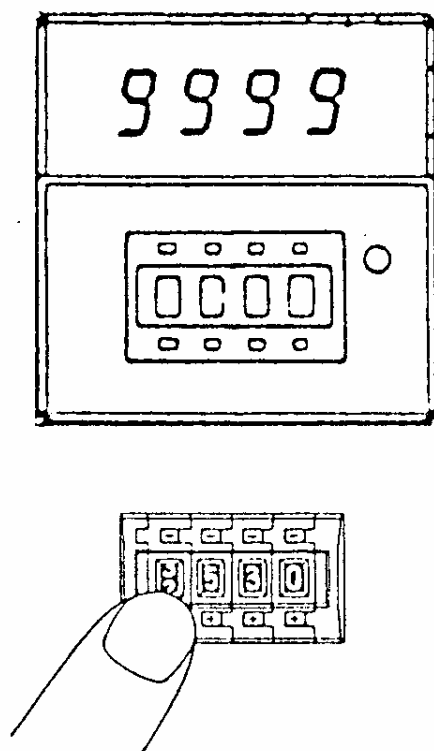

**TIMED CYCLE MODE**

**From s/n 14915**

The Omron H3CA timer can be set to any time in the range 0.1s to 9990h by combining the three thumbwheel switch modules for time setting and the fourth switch module for time unit selection.

| Selector | Range               |
|----------|---------------------|
| 0.1s     | 0.1s to 99.9s       |
| s        | 1s to 999s          |
| 0.1min.  | 0.1min. to 99.9min. |
| min.     | 1min. to 999min.    |
| 0.1hrs   | 0.1hrs to 99.9hrs   |
| hr       | 1 to 999hrs         |
| 10hrs    | 10hrs to 9990hrs    |

A 10 segment LCD displays a time remaining bar graph and output status indicators.

Ensure the leftmost thumbwheel switch is set to 'A' 'ON-delay'.

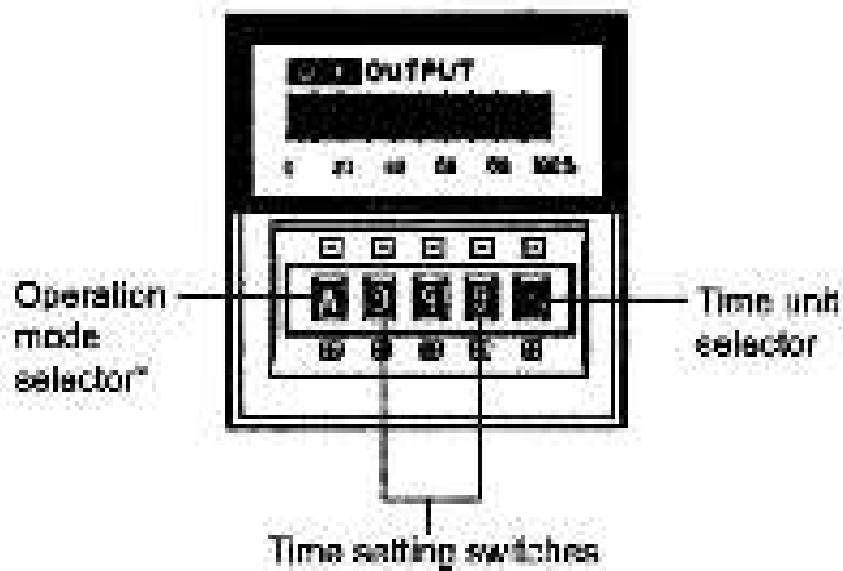

## TEMPERATURE CONTROLLER

### E5CS

The temperature controller is located on the right hand side of the sloping control panel on the front of the instrument.

The digital fluid bed dryer features a self-optimising PID controller for the range 0 - 200<sup>0</sup>C. The fascia has LED digital temperature indication, LED indicators for deviation, mode and operation of outputs, setting keys and temperature indication switching key (the positions of these are shown on the diagram below).

The temperature controller regulates the heater that raises the temperature of the air fed to the sample by the dryer. It will only operate if the heater switch is in the ON position. When first energised, there is a short self-check procedure and then the display shows the process air temperature.

To set the control temperature, press the switching key (the left one of the three) once. The letters SP appear in the bottom left corner of the display and the two arrowed keys can now be used to change the display to the desired value. Press the switching key twice and the display reverts to process temperature.

On the left hand side of the display are the three deviation indicators; a red down-arrow indicates that process temp. is below set temp., a green square that temp. is near to set temp., and a red up-arrow for over temperature.

The output operation indicator is a red square in the top right of the display.

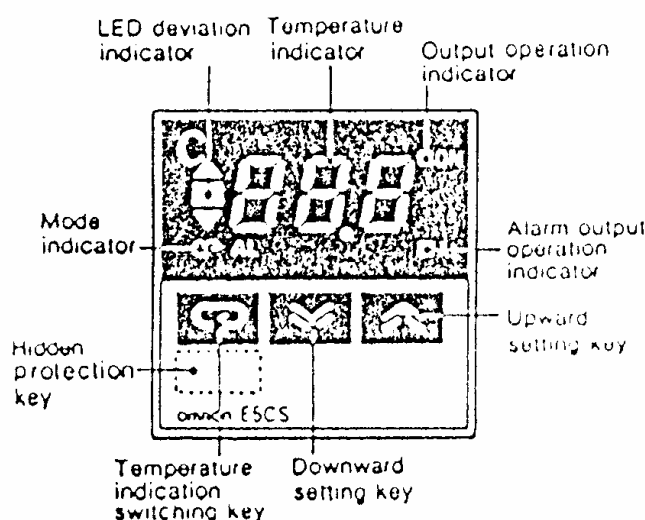

## TEMPERATURE CONTROLLER

### E5CN

The Omron E5CN temperature controller can be set to any temperature in the range ambient to 200°C by pressing the up or down arrow keys to change the set value in display 2.

The temperature controller regulates the heater that raises the temperature of the air fed to the sample by the dryer. It will only operate if the heater switch is in the ON position.

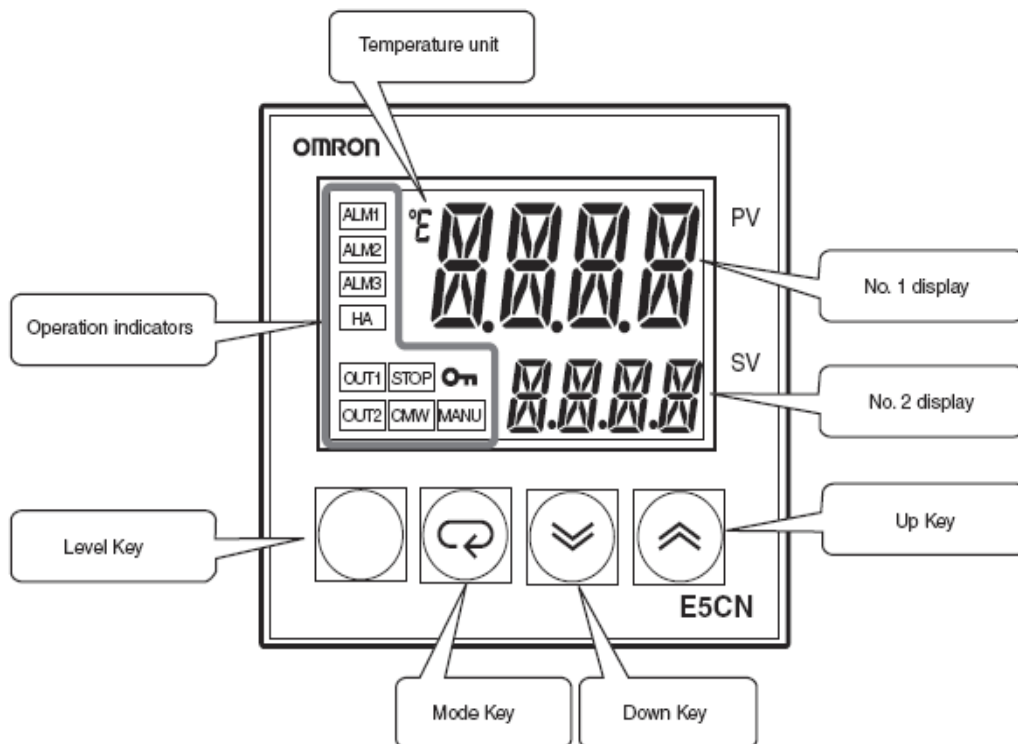

#### **Level Key**

Use this key to change levels within the menu.

#### **Mode Key**

Press this key to change the contents of the display. Press for 1s or longer for reverse scroll.

#### **Up & Down Keys**

Use these keys to change the values on the No.2 display.

#### **No.2 Display**

Set point, set data read-out value or changed input value.

#### **No.1 Display**

Process value or set data symbol.

Temperature Unit

The Initial Settings and Advanced Functions are protected from alteration from the factory default.

# 5

## GENERAL MAINTENANCE

BEFORE STARTING ANY MAINTENANCE PROCEDURE ON THE FLUID BED DRYER MAKE SURE THAT IT IS DISCONNECTED FROM THE ELECTRICAL SUPPLY AND READ ALL THE INSTRUCTIONS THOROUGHLY. THIS IS FOR YOUR SAFETY AND TO PREVENT DAMAGE TO THE INSTRUMENT.

### 5.1 DISASSEMBLY

In order to carry out any of the maintenance procedures explained below the instrument has to be disassembled. This is carried out in the following manner:

1. On a clear worktop cover the surface with a soft cloth to prevent scratching the instrument's painted finish. Lie the fluid bed dryer on its side on this surface. Undo the 3/8" bolt in the base of the machine.
2. Place the instrument upright and undo the screws fixing the case together (No.8x3/8" self-tap, 5 per side and 2 on the top).
3. While facing the front of the instrument carefully remove the top cover by gently pulling out the sides to clear the base and lifting until completely clear of the base section. Lie the top section on its side to the left of the base. Note: the wires do not have to be disconnected if the two parts are kept close together.
4. Support the weight of the casting hanging inside the top cover by placing a suitable block between the casting and the inside of the top cover.

At this stage all the internal components should be accessible.

### 5.2 REPLACEMENTS

#### 5.2.1 HEATER ELEMENT

Remove top cover, remove four screws holding housing on to the base plate, disconnect wires and remove heater housing. Remove screws securing the heater into the housing and withdraw the heater. Reverse procedure to fit replacement.

#### 5.2.2 TEMPERATURE CONTROLLER

Withdraw controller from its sleeve by pulling from the front panel.

**5.2.3 BLOWER SPEED CONTROLLER**

Remove knob by slackening small screw. Remove top cover, unscrew two screws securing controller to fixing bracket. Disconnect wires and withdraw controller. Replace using reverse procedure.

**BLOWER SPEED**

As both motor and speed controller are subject to variations in voltage and frequency, variations in speed/control ratio will occur and are more apparent at the lower settings.

Dryers are normally set and tested at 240V 50Hz unless otherwise specified.

**5.3 REMOVAL OF AIR INLET FILTER FOR CLEANING**

Remove top cover. Locate the wire mesh air inlet filter mounted on the end of the motor. Remove the two screws to release the clip holding the air filter to the housing. Clean by washing, rinsing and drying. When dry blow out any remaining dust. Replace using reverse procedure.



# Sherwood Scientific Limited

## Product Warranty Statement

---

**Warranty Term:                    12 Months**

Sherwood Scientific Ltd (Sherwood) warrants, subject to the conditions itemised within this document, through either Sherwood personnel or personnel of its authorised distributors, to repair or replace free of all charges, including labour, any part of this product which fails within the warranty time specified above, appertaining to this particular product. Such failure must have occurred because of a defect in material or workmanship and not have occurred as a result of operation of the product other than in accordance with procedures described in the instructions furnished with this product.

Conditions and specific exceptions that apply to the above statement are as follows:

1. End-user warranty time commences on the date of the delivery of product to end-user premises.
2. '*Free of all charges*' statement applies only in areas recognised by Sherwood as being serviced either directly by its own personnel, or indirectly through personnel of an authorised distributor. Products purchased outside these areas requiring service during the warranty period will incur charges relative to the travel/transit costs involved. However, products purchased in such areas will be serviced during the warranty period free of all charges providing they are returned, carriage paid, to either Sherwood or by pre-arrangement to an authorised Sherwood distributor.
3. All maintenance (other than operator maintenance as described in the instructions), repairs or modifications have been made by Sherwood or Sherwood authorised personnel.
4. This product has where applicable been operated using Sherwood specified supplies and reagents.
5. Sherwood reserves the right to make any changes in the design or construction of future products of this type at any time, without incurring any obligation to make any changes whatsoever to this particular product.
6. Reagents, supplies, consumables, accessories and user maintenance items are not included in this warranty.

## Product Warranty Statement (continued)

7. Repairs or replacement of any part failing due to abnormal conditions including the following, are excluded from this warranty:
  - a. Flood, lightning, earthquake, tornado, hurricane, or any other natural or man-made disaster.
  - b. Fire, bombing, armed conflict, malicious mischief or sprinkler damage.
  - c. Physical abuse, misuse, sabotage or electrical surge.
  - d. Damage incurred in moving the product to another location.
  
8. User agrees to permit Sherwood personnel or personnel of its authorised distributor to make changes in the product which do not affect results obtained, but do improve product reliability.

Representations and warranties purporting to be on behalf of Sherwood made by any person, including distributors and representatives of Sherwood, which are inconsistent or in conflict with the terms of this warranty (including but not limited to the limitations of the liability of Sherwood as set forth above), shall not be binding upon Sherwood unless reduced to writing and approved by an officer of Sherwood Scientific Ltd.

Except for the obligations specifically set forth in this warranty statement, in no event shall Sherwood be liable for any direct, indirect, special, incidental, or consequential damages, whether based on contract, tort or any other legal theory and whether advised of the possibility of such damages.

Neither Sherwood nor any of its third party suppliers makes any other warranty of any kind, whether expressed or implied, with respect to Sherwood Products.

Sherwood Scientific Ltd.,  
1 The Paddocks,  
Cherry Hinton Road,  
Cambridge,  
CB1 8DH,  
England